



Preparation of Work

Special Caution Items For This Car

1. Fuel Line Servicing

- Relieve fuel pressure by loosening the service bolt provided on the top of the fuel filter before disconnecting a fuel hose or a fuel pipe.

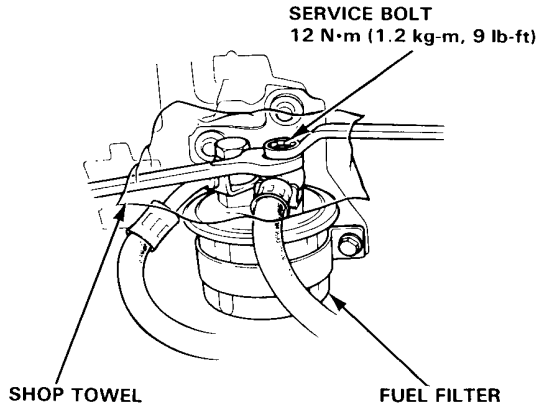

- Be sure to replace washers, O-rings, and rubber seals with new ones when servicing fuel line parts.
- Always apply oil to the surfaces of O-rings and seal rings before installation. Never use brake fluid, radiator fluid, vegetable oils or alcohol-based oils.

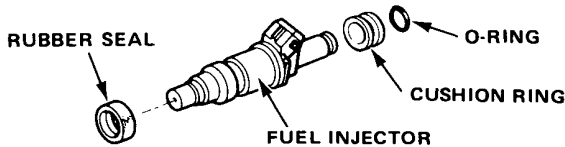

- When assembling the flare joint of the high-pressure fuel line, clean the joint and coat with new engine oil.
- When installing an injector, check the angle of the coupler. The center line of the coupler should align with the setting mark on the injector holder.

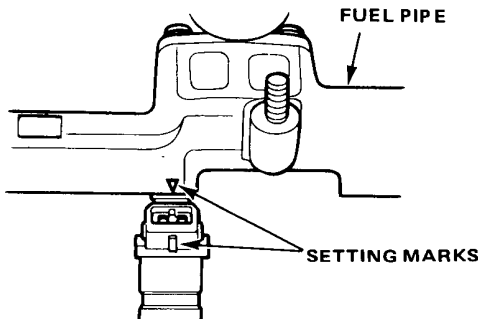

2. Inspection for fuel leakage

- After assembling fuel line parts, turn ON the ignition switch (do not operate the starter) so that the fuel pump is operated for approximately two seconds and the fuel is pressurized. Repeat this operation two or three times and check whether any fuel leakage has occurred in any of the various points in the fuel line.

3. Installation of an amateur radio.

Care has been taken for the PGM-FI ECU (control unit) and its wiring to prevent erroneous operation from external interference, but erroneous operation of the control unit may be caused by extremely strong radio waves. Attention must be paid to the following items to prevent erroneous operation of the control unit.

- The antenna and the body of the radio must be at least 200 mm (7.9 in.) away from the computer.

The control unit location:

- PGM-FI ECU: Passenger's side front lower panel
- Do not lead the antenna feeder and the coaxial cable over a long distance parallel to the car's wiring. When crossing with the wiring is required, execute crossing at a right angle.
- Do not install a radio with a large output (max. 10 W).

4. Apply liquid gasket to the transmission, oil pump cover, right side cover and water outlet. Use Honda genuine liquid gasket, PART NO. 0Y740-99986.

- Check that the mating surfaces are clean and dry before applying liquid gasket. Degrease the mating surfaces if necessary.
- Apply liquid gasket evenly, being careful to cover all the mating surface.
- To prevent leakage of oil, apply liquid gasket to the inner threads of the bolt holes.
- Do not install the parts if 20 minutes or more have passed after applying liquid gasket. In that case, reapply liquid gasket after removing old one.
- After assembly, wait at least 30 minutes before filling the appropriate liquid (engine oil, coolant and other similar fluid).

Preparation of Work

CAUTION: Observe all safety precautions and notes while working.

1. Protect all painted surfaces and seats against dirt and scratches with a clean cloth or vinyl cover.

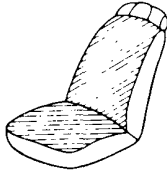

2. Work safely and give your work your undivided attention. When either the front or rear wheels are to be raised, block the remaining wheels securely. Communicate as frequently as possible when work involves two or more workers. Do not run the engine unless the shop or working area is well ventilated.

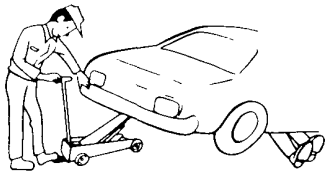

3. Prior to removing or disassembling parts, they must be inspected carefully to isolate the cause for which service is necessary. Observe all safety notes and precautions and follow the proper procedures as described in this manual.



4. Mark or place all removed parts in order in a parts rack so they can be reassembled in their original places.

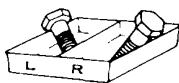

5. Use the special tools when use of such is specified.

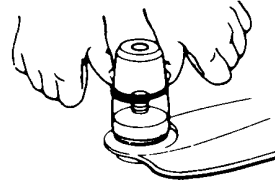

6. Parts must be assembled with the proper torque according to the maintenance standards established.
7. When tightening a series bolts or nuts, begin with the center or large diameter bolts and tighten them in crisscross pattern in two or more steps.

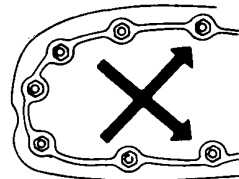

8. Use new packings, gaskets, O-rings and cotter pins whenever reassembling.

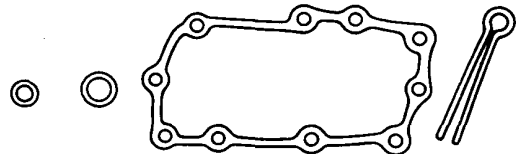

9. Use genuine HONDA parts and lubricants or those equivalent. When parts are to be reused, they must be inspected carefully to make sure they are not damaged or deteriorated and are in good usable condition.

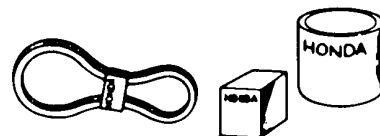



10. Coat or fill parts with specified grease as specified (Page 4-2). Clean all removed parts with solvent upon disassembly.

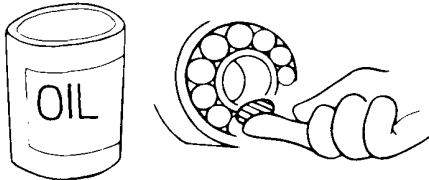

11. Brake fluid and hydraulic components

- When replenishing the system, use extreme care to prevent dust and dirt from entering the system.
- Do not mix different brands of fluid as they may not be compatible.
- Do not reuse drained brake fluid.
- Brake fluid can cause damage to painted surfaces. Wipe up spilled fluid at once.
- After disconnecting brake hoses or pipes, be sure to plug the openings to prevent loss of brake fluid.
- Clean all disassembled parts only in clean BRAKE FLUID. Blow open all holes and passages with compressed air.



- Keep disassembled parts from air-borne dust and abrasives.
- Check that parts are clean before assembly.

12. Avoid oil or grease getting on rubber parts and tubes, unless specified.
13. Upon assembling, check every part for proper installation and operation.

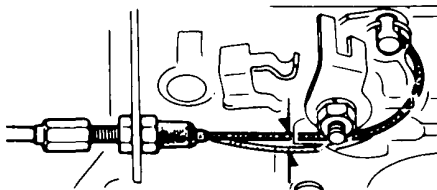

Electrical

- Before making any repairs on electric wires or parts, disconnect the battery cables from the battery starting with the negative (-) terminal.

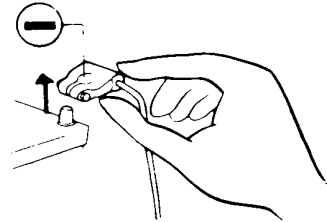

- After making repairs, check each wire or part for proper routing and installation. Also check to see that they are connected properly.
- Always connect the battery positive (+) cable first, then connect the negative (-) cable.

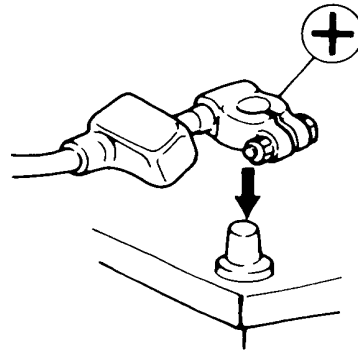

- Coat the terminals with clean grease after connecting the battery cables.
- Don't forget to install the terminal cover over the positive battery terminal after connecting.
- Before installing a new fuse, isolate the cause and take corrective measures, particularly when frequent fuse failure occurs.

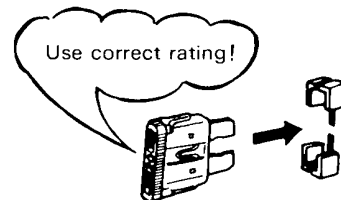

- Be sure to install the terminal cover over the connections after a wire or wire harness has been connected.

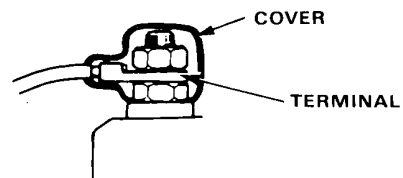

(cont'd)

Preparation of Work

Electrical (cont'd)

- When removing locking couplers, be sure to disengage the lock before disconnecting.
- Couplers may be of two types, those in which the lock is pressed to remove, and those in which the lock is pulled up to remove. Be sure to ascertain the type of locking device before beginning work. The following is a depiction of the means of disconnecting various typical couplers.

Press to disengage:

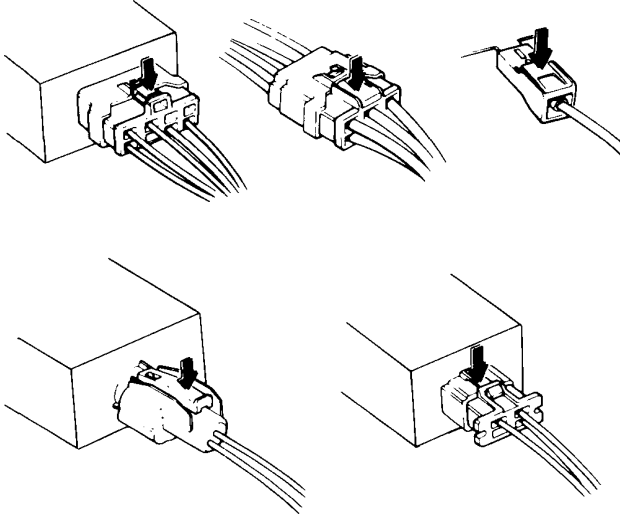

Pull up to disengage:

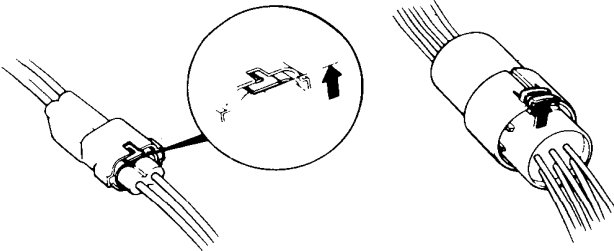

- When disconnecting locks, first press in the coupler tightly (to provide clearance to the locking device), then operate the tab fully and remove the coupler in the designated manner.

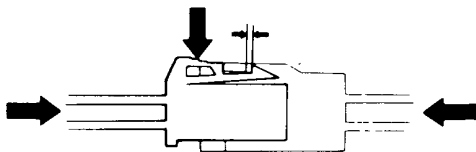

- All plastic plugs have locking tabs that must be released before disconnecting, and must be aligned when reconnecting.

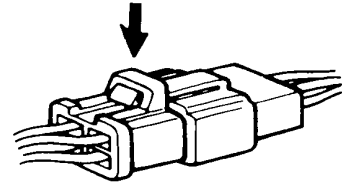

- When disconnecting a coupler, pull it off from the mating coupler by holding on both couplers.
- Never try to disconnect couplers by pulling on their wires.



- Before connecting couplers, check to see that the terminals are in place and are not bent or distorted.

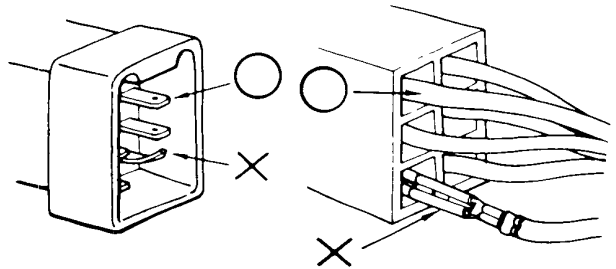

- Insert couplers fully until they will no longer go.
- Some couplers have locking tabs that must be aligned and engaged securely.
- Don't use wire harnesses with a loose wire or coupler.

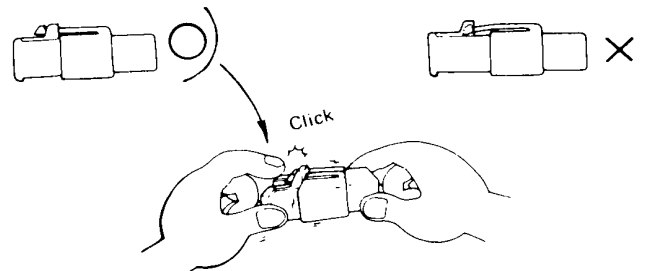

- Place the plastic cover over the mating coupler after reconnecting. Also check that the cover is not distorted.

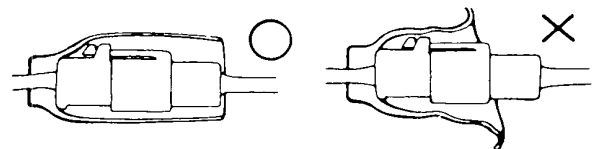



- Before clamping, check each connector cover for damage. Also make sure that the female connector is tight and not loosened from the previous use.

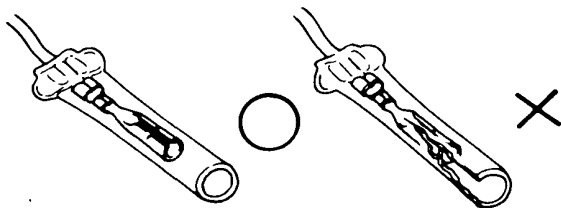

- Insert male connectors into the female connectors fully until they will no longer go.
- Be sure that plastic cover is placed over the connection.
- Position the wires so that the open end of the cover is not facing upward.

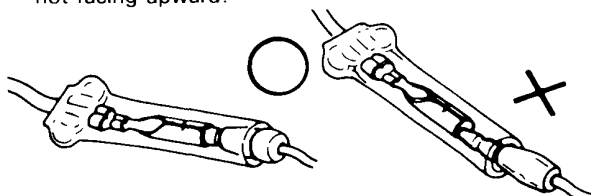

- Secure wires and wire harnesses to the frame with their respective wire bands at the designated locations. Position the wiring in the bands so that only the insulated surfaces contact the wires or wire harnesses.

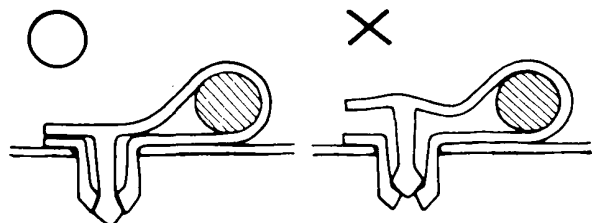

- A loose wire harness or cable can be a hazard to safety. After clamping, check each wire for security in its clamp.

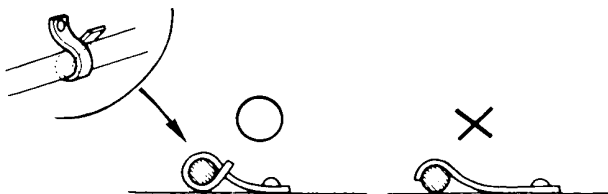

- Do not squeeze wires against the weld when a weld-on clamp is used.



- After clamping, check each harness to be certain that it is not interfering with any moving or sliding parts of the vehicle.
- Keep wire harnesses away from the exhaust pipes and other hot parts.

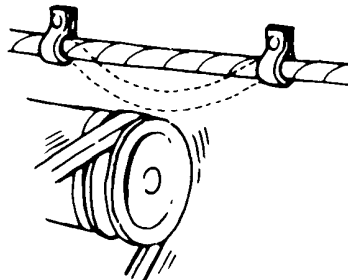

- Always keep a safe distance between wire harnesses and any heated parts.

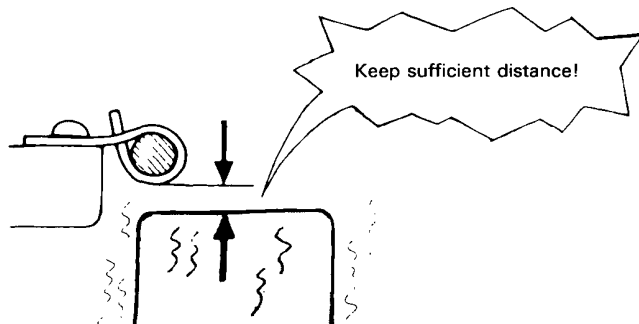

- Do not bring wire harnesses in direct contact with sharp edges or corners.
- Also avoid contact with the projected ends of bolts, screws and other fasteners.

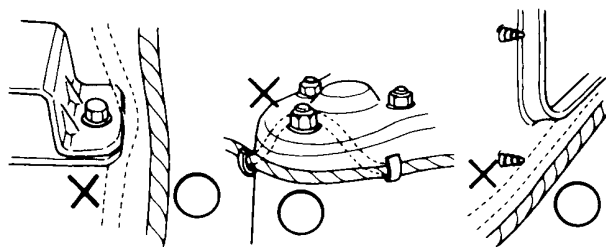

- Route harnesses so they are not pulled taut or slacked excessively.

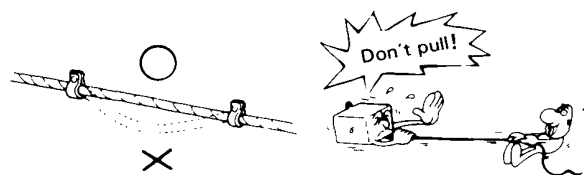

(cont'd)

Preparation of Work

Electrical (cont'd)

- Protect wires and harnesses with tape or a tube if they are in contact with a sharp edge or corner.

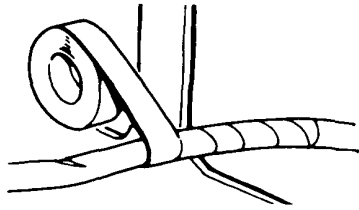

- Clean the attaching surface thoroughly if an adhesive is used. First, wipe with solvent or alcohol if necessary.

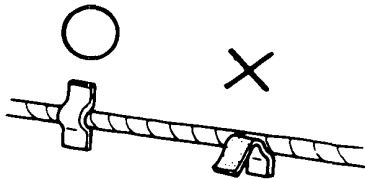

- Seat grommets in their grooves properly.

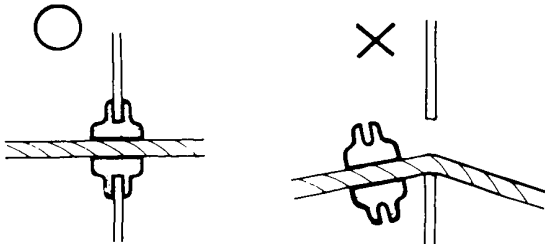

- Do not damage the insulation when connecting a wire.
- Do not use wires or harnesses with a broken insulation. Repair by wrapping with protective tape or replace with new ones if necessary.

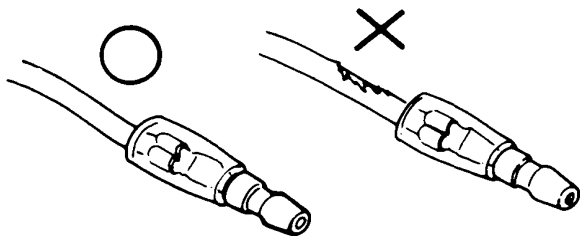

- After installing parts, make sure that wire harnesses are not pinched.

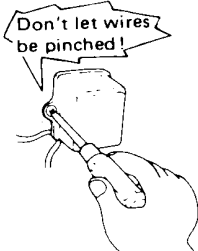

- After routing, check that the wire harnesses are not twisted or kinked.

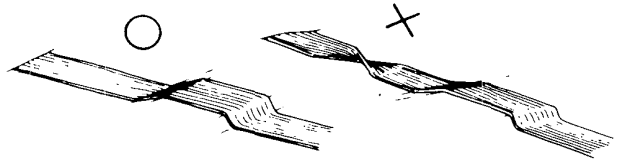

- Wire harnesses should be routed so that they are not pulled taut, slacked excessively, pinched, or interfering with adjacent or surrounding parts in all steering positions.

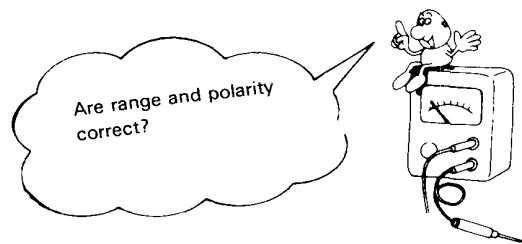

- When using the Service Tester, follow the manufacturer's instructions and those described in the Shop Manual.

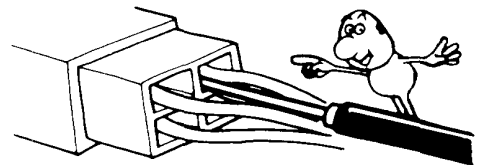

- Do not drop parts.



- Rust is the enemy of all finished surfaces. Before connecting connectors and couplers, check the terminals and remove, if any, rust using a fine sand paper or emery cloth.

